



PROSENSE DPX Configurator 

Software Manual

Prosense Teknoloji San. Ltd. Őti.

www.prosense.com.tr

Index

1. Introduction.....	2
1.1. Scope	2
1.2. Purpose.....	2
1.3. Who should use this document.....	2
1.4. References	2
1.5. Prerequisites.....	2
1.6. Compatible Gas Alarm Panels	2
2. Panel Configuration.....	3
2.1.Panel Configuration.....	3
2.2.Panel Connection	3
3. RS485 Port Configuration	4
4. Software Installation	4
5. Software Menus	5
5.1. Software Version	5
5.2. Overview.....	5
5.3. File Menu.....	7
5.4. Settings Menu	8
5.4.1 Comm Settings	8
5.4.2 Language	8
5.5. Configuration Menu	9
5.5.1 Panel Settings	9
5.5.2 Detectors	11
5.5.3 Relays.....	13
5.5.4 Events	14
5.5.5 Relay and Event Relation.....	15
5.6. Transfer	16

1. Introduction

1.1.Scope

Prosense DPX Series Gas Alarm Panels can be configured with DPX Configurator software. DPX Configurator is produced for easy configuration, event programming, configuration back-up, data upload and download for Prosense DPX Series Gas Alarm Panels. This software communicates with panel via RS-485 connection. This manual includes information about usage of DPX Configurator software.

1.2.Purpose

This manual is designed to guide users about usage of this software and configuration of DPX Series Gas Alarm Panels.

1.3.Who should use this document

This manual is created for Prosense partners and distributors. Please contact Prosense for additional information.

1.4.References

- Prosense DPX Series Modbus Communication Manual
- DPX Series Gas Control Panel User Manual
- DPX Relay Output Module Manual

1.5.Prerequisites

- USB to RS485 converter or onboard RS485 port.
- Microsoft .NET Framework 4.7.2

1.6.Compatible Gas Alarm Panels

DPX-4, DPX-8, DPX-32, DPX-64, DPX-128 Series with firmware version 5.3.0 and later are compatible with this software.

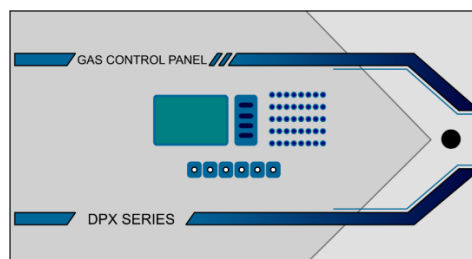

2. Panel Configuration

This section describes panel connections and settings for software communication. Panel Id(address) must be configured or known before performing connection. All DPX Series Panels have a built-in RS-485 port. Panel Id can be assigned via menu steps.

2.1. Panel Configuration

Default panel Id is "1". To change panel Id, follow the menu steps below. Default panel menu password is "1234". Up and down buttons are used for selecting the sub-menus or changing the values. Press the menu button to confirm selection.

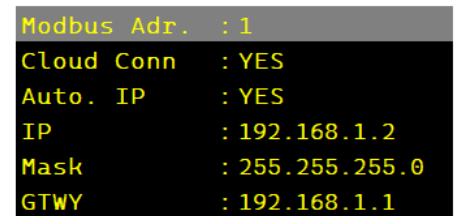
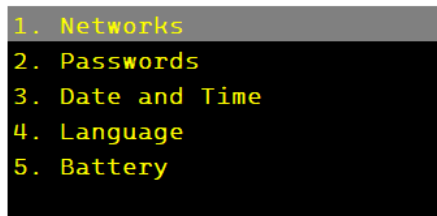
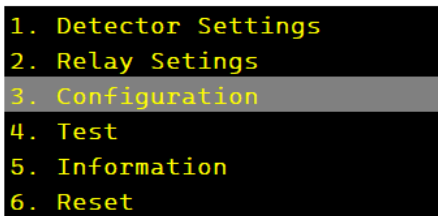

2.2. Panel Connection

RS-485 port is located on the top left of the mainboard. A suitable RS-485/USB converter must be used for communication.

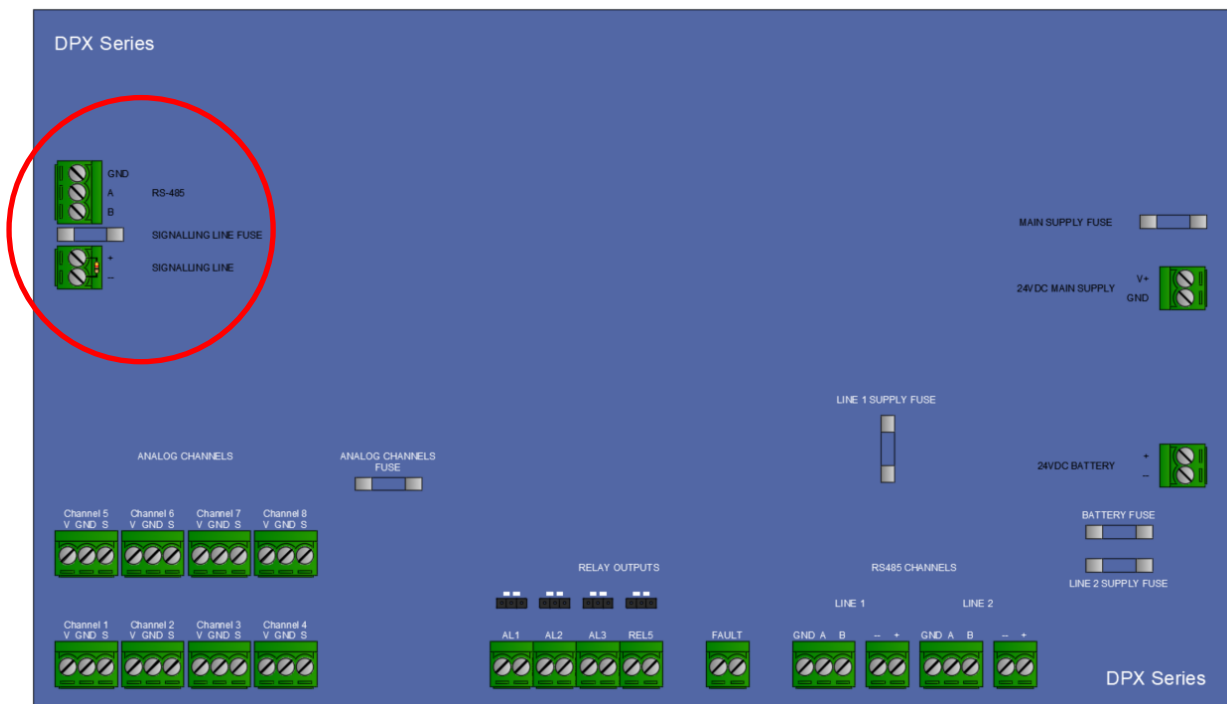

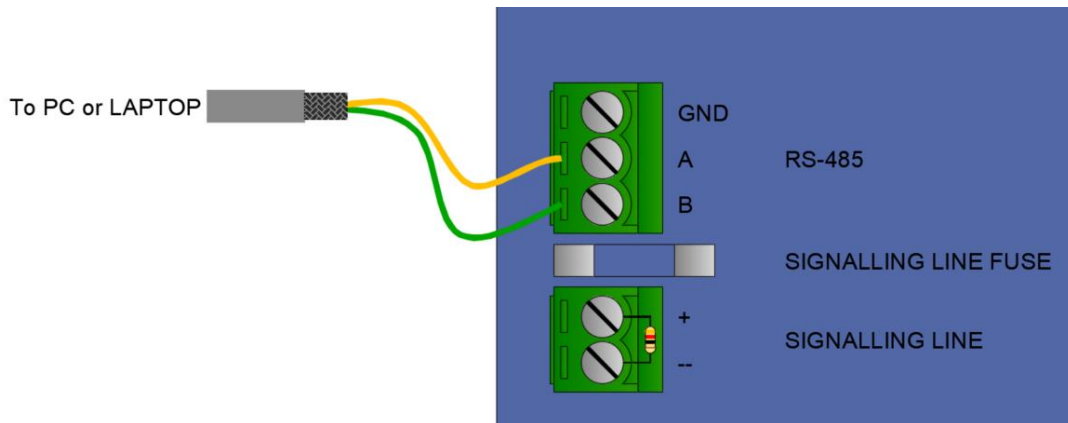

3. RS485 Port Configuration

A and B socket of panel must be connected to RS485 converter. Please check for a properly configured serial port via device manager. For USB to serial converters, suitable drivers must be installed.

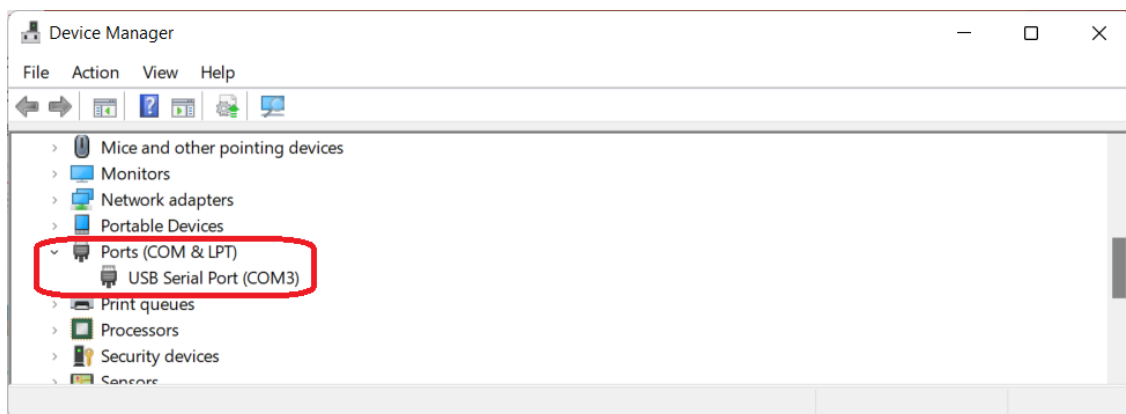

4. Software Installation

Before installing DPX-Configurator, please make sure .Net Framework 4.7.2 or later is installed.

To start installation double click the setup file and follow instructions. If a previous version is installed, software will guide you through “repair”, “upgrade” or “remove” options. If “repair” or “upgrade” is selected, software will upgrade the files in the previous installation directory. If “remove” is selected software will be uninstalled.

In some cases, installation files could not be replaced or upgraded for Windows security purposes. Please, always check the software version and modified date of the configuration files after installation to make sure the installation completed successfully. In case you notice upgrading or repairing the software is unsuccessful, please delete the files manually in the installation folder after uninstallation and install the software again.

5. Software Menus

To open the configurator, use desktop or start menu shortcut.

5.1. Software Version

Software version is shown at the title bar. Please check if the software version is correct. If not, refer to “4. Software Installation”

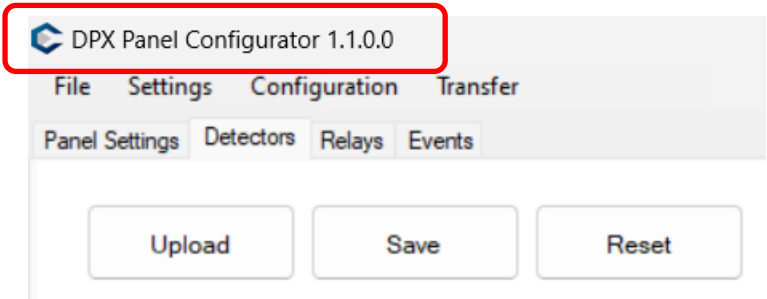

5.2. Overview

Main menu of the software is shown below.

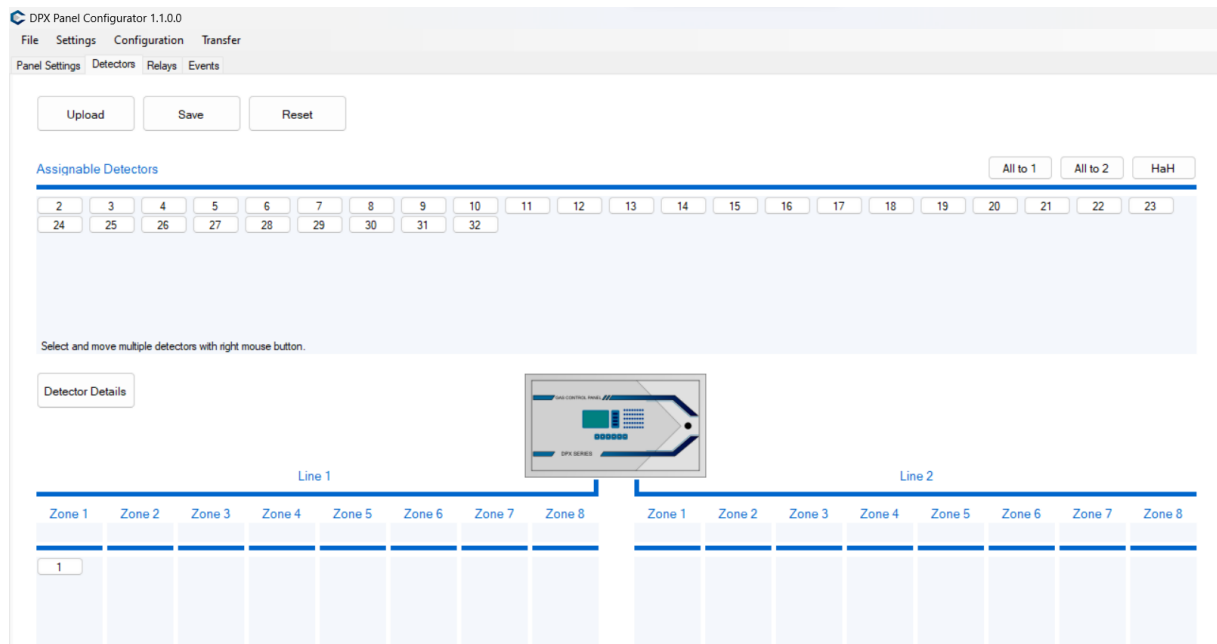

For further actions and menus, please use the Menu Bar.

Below menu tree can be used as quick guidance and summary for the functions.

File

- Save Configuration : To save configuration
- Load Configuration : To load a backup file
- Backup Configuration : To backup current configuration
- Export Report : Export panel report in pdf format
- Reset Configuration : Resets configuration
- Exit : Exits software

Settings

- Comm Settings : Communication parameter configuration
- Language : Selects software language

Configuration

- Panel : Settings related to panel
- Detectors : Settings for detectors, zones, lines
- Relays : Settings for relay modules
- Events : Settings for event actions

Transfer

- Download From Panel : Downloads data from panel to software
- Upload All To Panel : Upload all configuration to panel
- Upload Segment : Used for partial uploads
 - *Upload Panel Configuration : Upload only panel configuration
 - *Upload Relay Configuration : Upload only relay configuration
 - *Upload Event Configuration : Upload only event configuration

5.3.File Menu

Below actions can be performed from File Tab.

Save Configuration: Saves panel configuration as default configuration to the installation folder.

Load Configuration: Opens a pop up window to select a backup file. DPX-Configurator back-up files are in Zip format. Note that if the button is selected, a confirmation window will be shown which indicates that if proceeded, current settings will be erased. Select “Yes” to proceed or “No” to cancel action. If “Yes” is selected, a backup file must be chosen. Selecting the backup file will automatically restart the software with new parameters.

Backup Configuration: Backups panel configuration in Zip format. This zip file can be used later via clicking the “Load Configuration” button.

Export Report: This action will create a report for the connected panel. To perform this action, a proper connection must be established before exporting the report. Exported reports will be saved automatically to the installation directory under the “Reports” folder. A report sample can be seen below.

Test ve Ölçüm Raporu / Test and Measurement Report		
Üretim Bilgileri / Production Info		
Panel Modeli	Panel Model	DPX-32
Seri Numarası	Serial Number	CX032678
Üretim Tarihi	Production Date	08/2023
FW Versiyonu	FW Version	05.03.01
FW Tarihi	FW Date	20.12.2023
Ölçüm Bilgileri / Measurement Info		
Giriş Gerilimi	Input Voltage	24.2 V
Çıkış Gerilimi	Output Voltage	24.0 V
Akü Gerilimi	Battery Voltage	00.0 V
Akü Adeti	Battery Quantity	0
Panel Tarihi	Panel Date	11.08.2017
Panel Saati	Panel Time	01:08:19
Ağ Bilgileri / Network Info		
Modbus Adresi	Modbus ID	1
DHCP	DHCP	Off
IP Adresi	IP Address	010.000.002.211
Ağ Maskesi	Netmask	255.255.254.000
Ağ Geçidi	Gateway	010.000.002.001
Rapor Tarihi	Report Date	22/01/2024 18:10:11



Reset Configuration: Resets the configuration to default parameters.

Exit: Exits the software.

5.4.Settings Menu

Users can access communication and language settings via this tab.

5.4.1 Comm Settings

Communication parameters for serial connection can be configured in this menu. Panel is the ID of the panel which is assigned via panel menu described in “2.1.Panel Configuration”.

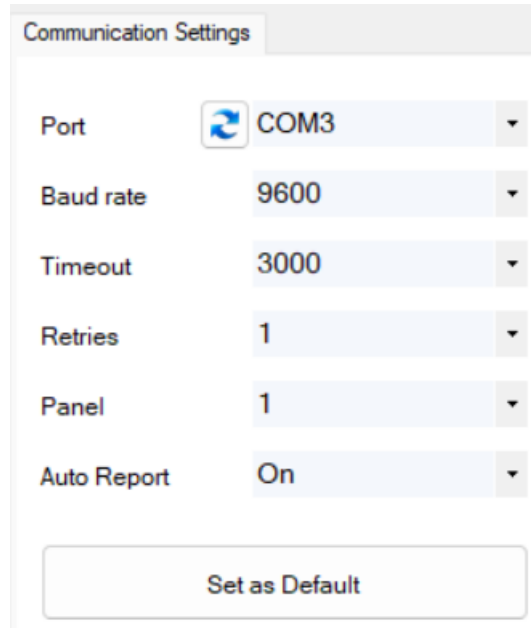

“Set as Default” button saves communication parameters as default values so when the software restarted or reopened, these parameters are loaded automatically.

Auto Report feature enables auto generated panel reports after configuration uploaded to panel.

5.4.2 Language

Active language is shown via check mark.

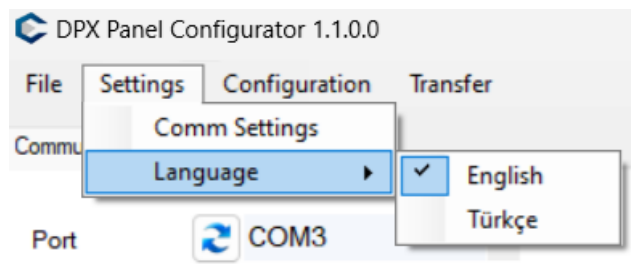

To apply the changes, software must be restarted.

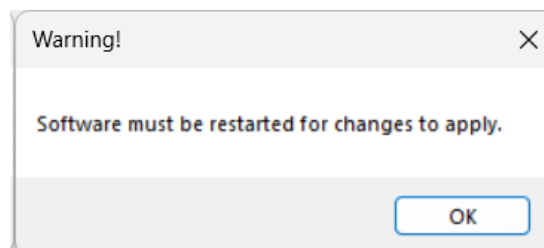

5.5.Configuration Menu

This menu is used for configuration of panel, detectors, relay modules and event actions. All settings can be done offline. Offline configurations can be saved and uploaded to the panel when needed.

In every sub menu there are buttons located on the top left side of the tab.



Upload : Used for uploading configuration partially for the active tab.

Save : Used for saving configuration for the active tab.

Reset : Used for resetting settings in the active tab.

Note that panel and detector configuration are always uploaded together.

5.5.1 Panel Settings

This menu is used for panel parameters.

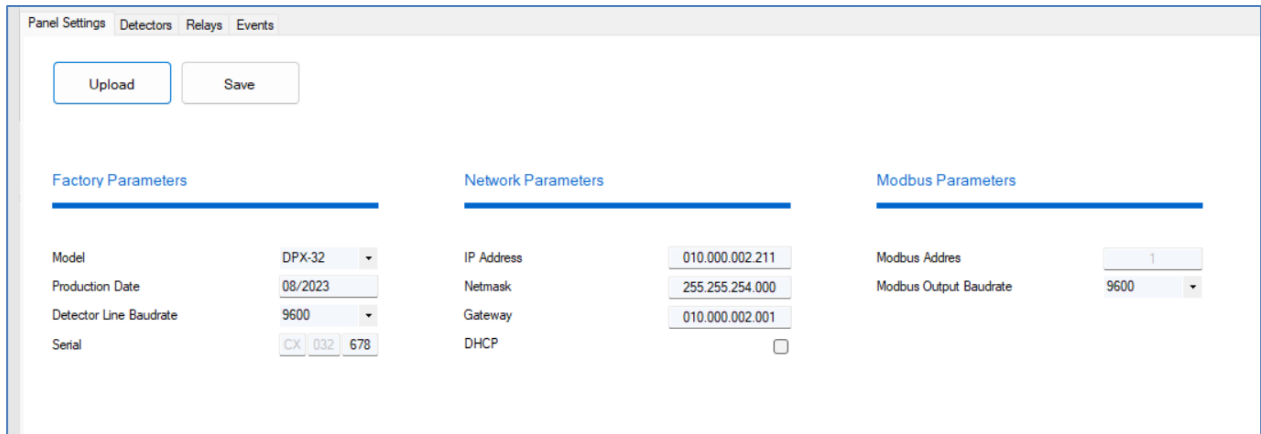

Factory Parameters

Model: Model for panel which is related to quantity of the detectors could be connected. Can be changed by users in offline mode. Note that changing model resets detector configuration as detector quantity and configuration is related to model number. Before uploading configuration to panel, software checks panel model and if there is a mismatch with configuration, data cannot be uploaded. Please make sure the panel model and configuration model matches before starting the programming.

Production Date: Production date for panel. Format is MM/YYYY. Cannot be changed by users.

Detector Line Baud rate: Factory default baud rate for detectors and panels are 9600 bps. For faster but more fragile connection, baud rate can be changed to 57600 bps. Note that this must be done for both detectors and panels.

Serial: Serial number for the panel. Cannot be changed by users.

Network Parameters

If an optional net-X module is used, panels can be connected to the data network.

IP Address: IP address setting for the panel.

Netmask: Netmask setting for the panel.

Gateway: Gateway setting for the panel.

DHCP: If checked, IP address will be automatically obtained. If not manually assigned network parameters will be used.

Modbus Parameters

Modbus Address: This setting cannot be changed with software. It could be changed via panel menu as described in “**2.1.Panel Configuration**”. This is the same ID used for connection in “**5.4.1. Comm Settings/Panel**”.

Modbus Output Baud rate: Baud rate of modbus rtu output of the panel can be programmed. Note that, if you change and upload this parameter, communication parameters as described in “**5.4.1. Comm Settings**”, must be updated before establishing connection again.

5.5.2 Detectors

This tab is used for assigning detectors to lines and zones. Detectors can be assigned custom texts. These names are not uploaded to panel but can be used as guidance for maintenance and service actions.

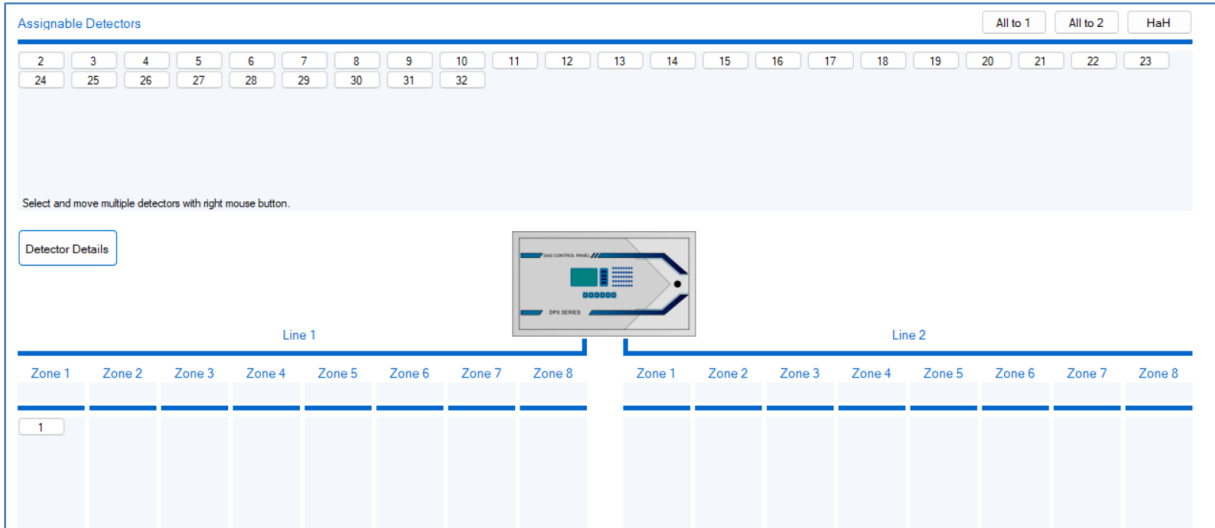

Each DPX panel has 2 physical lines and 8 configurable zones. Simply drag and drop detectors to Lines and Zones to assign detectors. In the example above, detector ID 1 is assigned to Line 1/Zone 1 and detectors 2 to 32 are not assigned.

Multiple detectors can be selected by pressing **Ctrl** button or right clicking. The **Delete** button can be used to cancel line and zone allocation and move the detector to the “**Assignable Detectors**” area. Detectors can be moved between zones/lines/assignable detector areas.

Top right 3 buttons are used for quick configuration.

All to 1 : Distributes all detectors to line 1.

All to 2 : Distributes all detectors to line 2.

HaH : Distributes all detectors evenly to line 1 and 2.

Below each zone, there is a custom text area. Users can enter texts for zones which could be used as guidance for maintenance and service actions.

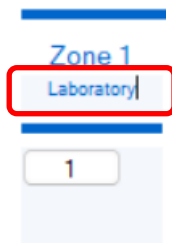

“**Detector Details**” button is used for entering custom texts for detectors. When clicked, “Detector Information” window will be opened.

Configured detectors will be shown in green and unassigned detectors will be shown in red. Each detector can be entered a custom location or information text. When saved or backed up, these texts are stored.

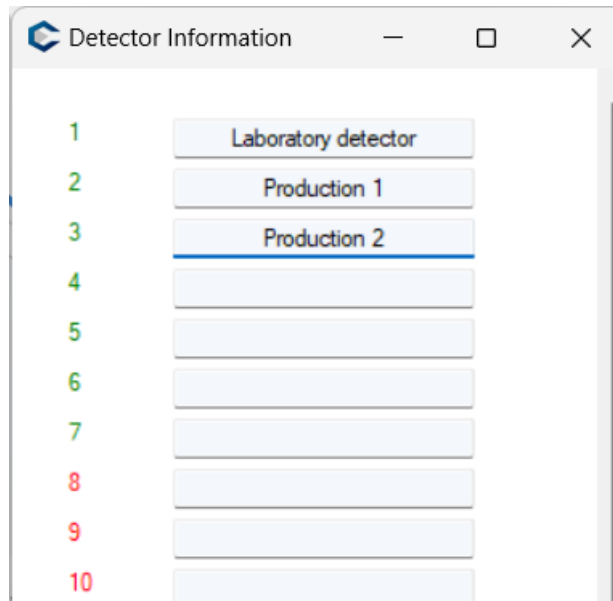

5.5.3 Relays

This tab is used for relay and relay module configuration. In total, 8 optional relay modules(each with 4 programmable relays) can be added to the communication line. Event Type and other relay settings for each 32 relays can be configured in this tab.

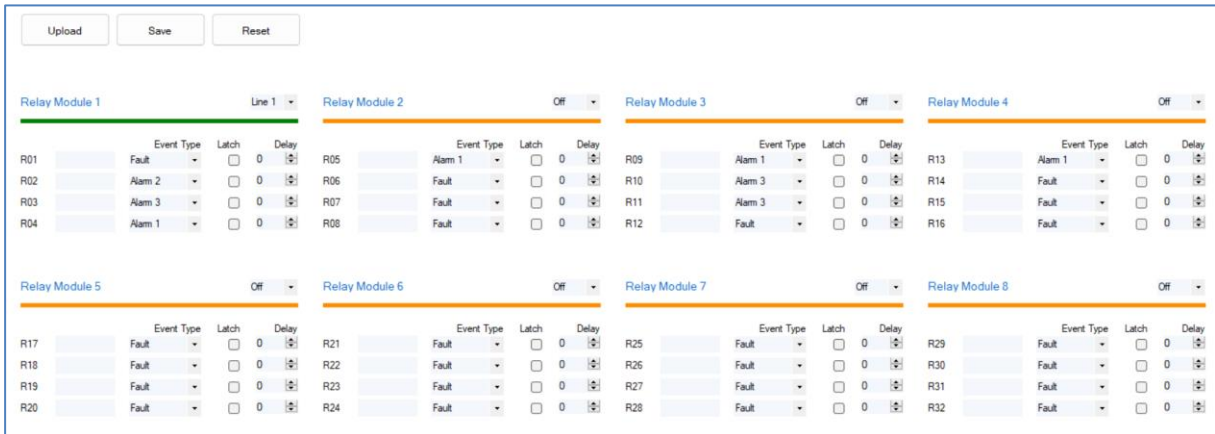

Assigned relay modules are shown with green line and unassigned modules shown in orange line.

Assigning modules to lines can be done with the selector In top right. Options are: **Off, Line 1, Line 2.**

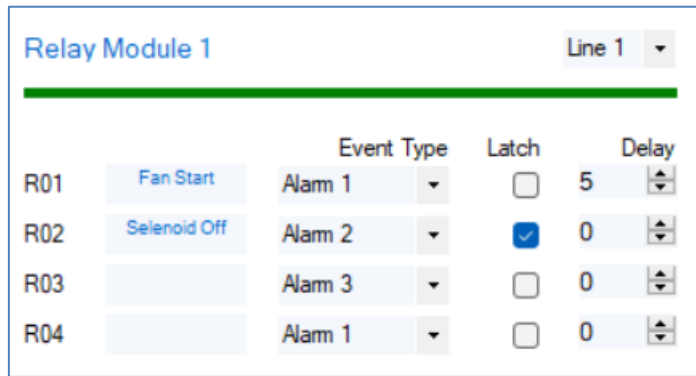

Event type for each relay can be selected. Options are: **Fault, Alarm 1, Alarm 2, Alarm 3** and **Over Range**. This means the relay will only be activated in selected the event type. If **Latch** is checked, relay will need a reset command for deactivation, if not, relay will automatically return to normal position if the related event disappears. **Delay** parameter is the off delay in minutes. When the related event returns to normal, the relay will be deactivated after **Delay** time.

Each relay can be entered a custom location or information text. When saved or backed up, these texts are stored. These texts are used for informational purposes in event programming, guidance for maintenance and service actions.

5.5.4 Events

This tab is used for event action programming. 3 relays can be assigned for each detector.

Assigned detectors will be shown in green and deactivated or unassigned detectors will be shown in red.

Upload
Save
Reset

Event 1							Event 2							Event 3						
	Relay	Detail	Event	Latch	Delay	Module		Relay	Detail	Event	Latch	Delay	Module		Relay	Detail	Event	Latch	Delay	Module
1	1	Fan Start	Alam 1	Off	5	1	2	2	Selenoid Off	Alam 2	On	0	1	3	0					
2	1	Fan Start	Alam 1	Off	5	1	4	0						4	0					
3	0						5	0						5	0					
4	0						6	0						6	0					
5	0						7	0						7	0					
6	0						8	0						8	0					
7	0																			
8	0																			

Users could select 3 event relays for each detector. When the relay numbers are selected, related relay information will be automatically updated which indicates the custom text, Event Type, Latch, Delay and the relay module number. This is for easy and correct action programming. If the relay module is not assigned to any lines, it will be shown with “(Off)” indication.

Event 1							Event 2						
	Relay	Detail	Event	Latch	Delay	Module		Relay	Detail	Event	Latch	Delay	Module
1	1	Fan Start	Alam 1	Off	5	1	2	2	Selenoid Off	Alam 2	On	0	1
2	1	Fan Start	Alam 1	Off	5	1	5	5	Not Programmed	Alam 1	Off	0	2 (Off)

5.5.5 Relay and Event Relation

Users must first configure relays and event types for each relay in **Relays** tab. Then in **Events** tab this relay number is associated with detectors.

In the example below, Detector 1 is configured to activate relay no 1. Relay no 1 is configured for Alarm 1 activation with no latch and 5 minutes off delay. With these settings, when “Alarm 1” occurs in detector 1, relay 1 will be activated. When “Alarm 1” of detector 1 returns to normal, relay 1 will be reset after 5 minutes of off delay.

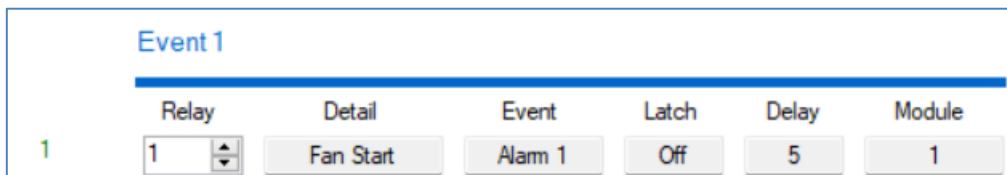

Event 1					
Relay	Detail	Event	Latch	Delay	Module
1	Fan Start	Alarm 1	Off	5	1

(Events Tab)

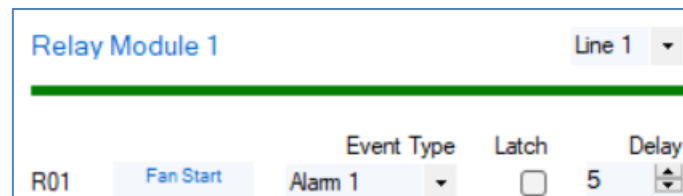

Relay Module 1				
Relay	Detail	Event Type	Latch	Delay
R01	Fan Start	Alarm 1	<input type="checkbox"/>	5

(Relays Tab)

5.6.Transfer

This menu is used for transferring data between the software and panel.

When any button is clicked, a popup progress window will be opened automatically which shows the current state of the action.

If download or upload fails, progress will be shown as:

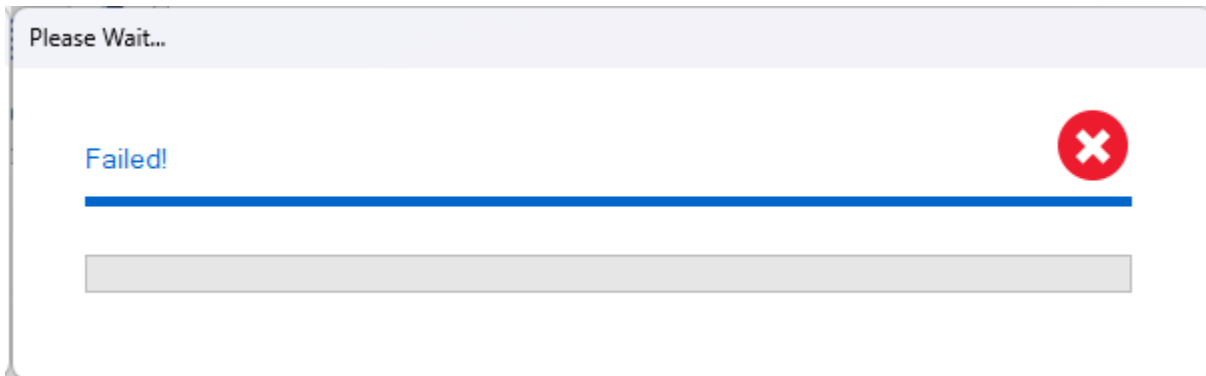

If Download or upload operation is ongoing, this will be shown as:

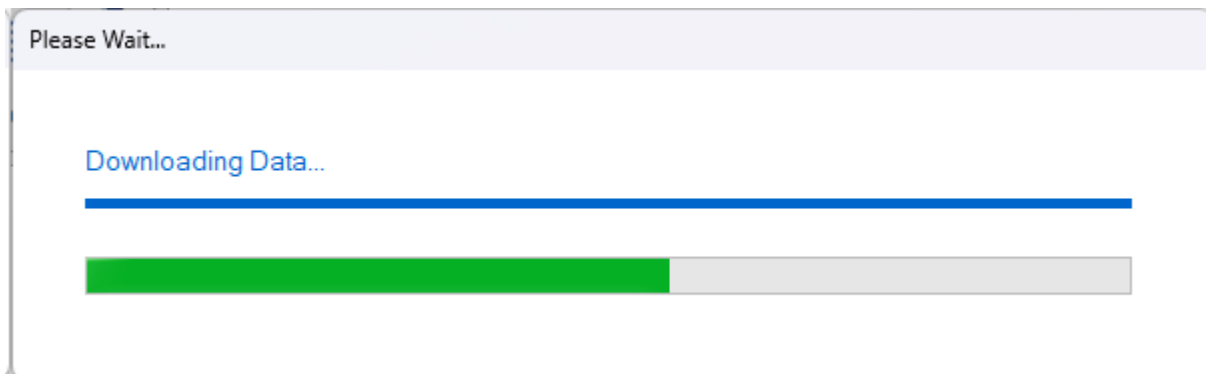

If download or upload operation completed successfully, this will be shown as:

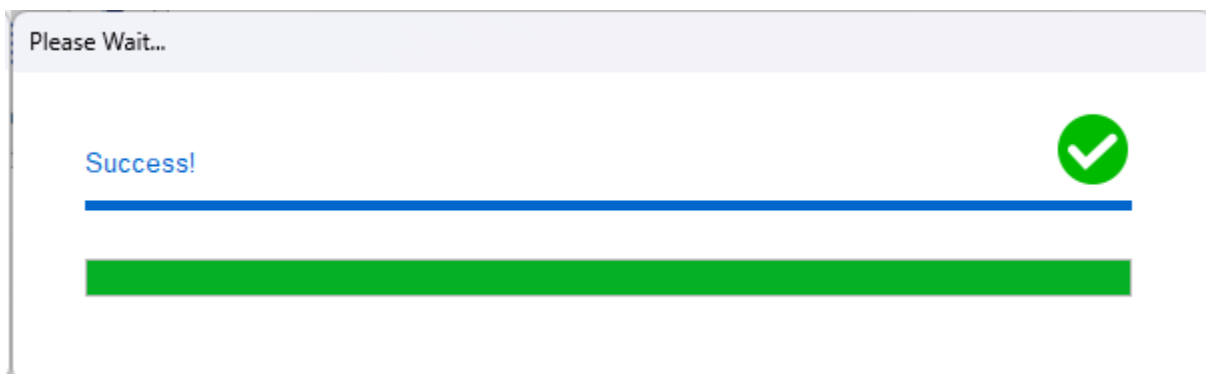

Download From Panel : This action will download configuration of the connected panel and update the software data. Note that, custom texts are for informational purposes only and not stored in the panel. Hence this information is not updated when the data is downloaded.

Upload All To Panel : Upload all the configuration(Panel Settings, Detectors, Relays and Events) to panel.

Upload Segment

Upload Panel Configuration : Uploads only Panel and Detector configuration to panel.

Upload Relay Configuration : Uploads only Relay configuration to panel.

Upload Event Configuration : Uploads only Event Configuration to panel.

If a firmware, version, model mismatch is detected, it will be prompted to users.